

TJL...Series  
DN15~DN50

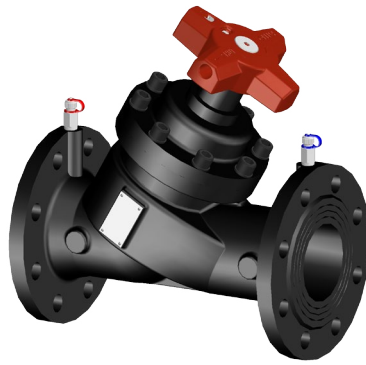

TJF...Series  
DN50~DN500

## Static Balancing Valve

### Features Introduction



#### • Digital Handwheel

Accurate scale on digital handwheel which could accurate to 0.1 cycle. The humanized design for numerical reading is convenient for operator to regulate flow value accurately and fast.



#### • Opening Lock Mode

The valve can be locked at random position to set the max. opening which will not affect the valve opening and close. After the valve locked, it could still regulating between 0 to the set max. opening.

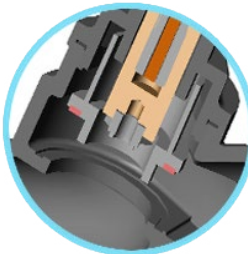

#### • Complete Close-off Design

Balancing valve core makes it easy to close the valve by rotating handwheel regardless of the medium pressure. Leakage of the valve is approximately "0" when shut off the valve.



#### • Self-sealing Test Plug

There are two test plugs on the both ports of the valve. Use a "Hydraulic Balancing Debugging Instrument" to measure the differential pressure value. Then you can easily regulate the flow by handwheel.



#### • High-quality Materials

Valve body is ductile iron QT450-10, valve core and stem are high-quality stainless steel, which has excellent corrosion resistance which greatly extend the lifetime of valve.

## Type Summary

Valve Body		Type PN16	Type PN25	Caliber [in.] DN [mm]		Kvs [m <sup>3</sup> /h]
Medium Temp. -10°~120°C		TJL15-T	TJL15-T-PN25	1/2"	15	5.8
		TJL20-T	TJL20-T-PN25	3/4"	20	8.0
		TJL25-T	TJL25-T-PN25	1"	25	11
		TJL32-T	TJL32-T-PN25	1 1/4"	32	17
		TJL40-T	TJL40-T-PN25	1 1/2"	40	25
		TJL50-T	TJL50-T-PN25	2"	50	34

Valve Body		Type PN16	Type PN25	Caliber [in.] DN [mm]		Kvs [m <sup>3</sup> /h]
Medium Temp. -10°~150°C		TJF50-T	TJF50-T-PN25	2"	50	55
		TJF65-T	TJF65-T-PN25	2 1/2"	65	107
		TJF80-T	TJF80-T-PN25	3"	80	145
		TJF100-T	TJF100-T-PN25	4"	100	259
		TJF125-T	TJF125-T-PN25	5"	125	430
		TJF150-T	TJF150-T-PN25	6"	150	647
		TJF200-T	TJF200-T-PN25	8"	200	1085
		TJF250-T	TJF250-T-PN25	10"	250	1630
		TJF300-T	TJF300-T-PN25	12"	300	2495
		TJF350-T	TJF350-T-PN25	14"	350	3229
		TJF400-T	TJF400-T-PN25	16"	400	4850
		TJF450-T	TJF450-T-PN25	18"	450	6305
		TJF500-T	TJF500-T-PN25	20"	500	8200

## Relationship between Differential Pressure and Flow

$$Kvs = \frac{V}{\sqrt{\frac{\Delta P}{100}}}$$

$\Delta P$ : Differential pressure when valve is full open (Unit: KPa)

V: Rating flow at the  $\Delta P$  (Unit: m<sup>3</sup>/h)

Kvs: Nominal flow coefficient, which refer to the flow when medium (Density= 1g/cm<sup>3</sup>) go through the full open control valve, whose  $\Delta P$  is 100KvPa.

## Installation Instruction

1. Remove the plug of valve first.
3. Pay attention to the flow of the medium: keep the same with direction mark on the valve body.
5. Flanges should be sealed.
7. In order to insure the valve works properly, there need a straight pipe which length is not less than 5 times of pipe diameter at the water inlet, and 2 times at the water outlet. (see Fig. 1)
2. Make sure that there are no sundries in the system before installation.
4. The valve installation directions are arbitrary. The valve is allowed to install downward only if the medium is clean.
6. The measuring joint need to be installed before medium flushes the valve.
8. Please reserve debugging space during installation, see the Fig.2 and Fig.3:

DN15-DN50: H1 > 200mm, H2 > 170mm

DN50-DN150: H1 > 200mm, H2 > 230mm

DN15-DN50: H1 > 200mm, H2 > 400mm

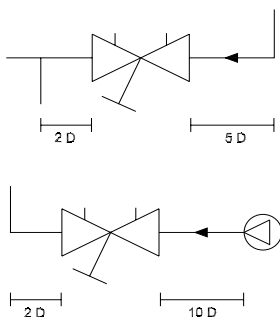

Figure 1

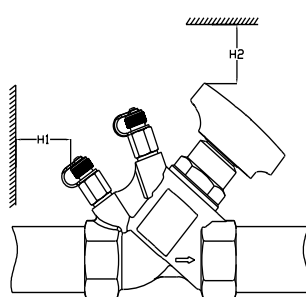

Figure 2

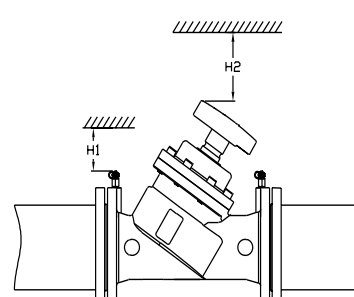
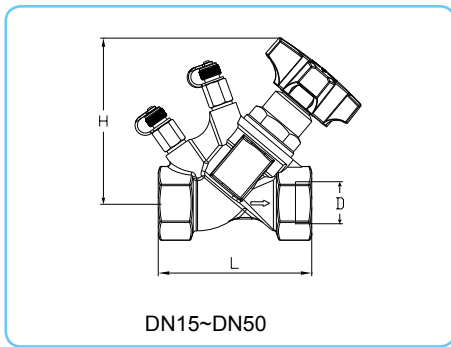
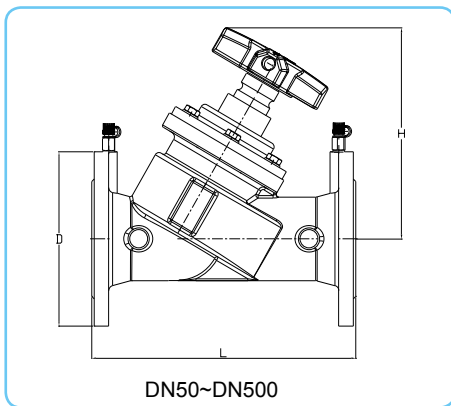

Figure 3

## Dimension Figure



DN	D mm	L mm	H mm	Weight kg
15	1/2"	80	102	0.8
20	3/4"	85	104	0.9
25	1"	98	105	1.2
32	1-1/4"	110	115	1.6
40	1-1/2"	120	122	2.0
50	2"	150	135	3.7



DN	PN16		PN25		L mm	H mm	Weight kg
	Bolt Aperture	D mm	Bolt Aperture	D mm			
50	4-19	165	4-19	165	230	214	11
65	4-19	185	8-19	185	290	222	15
80	8-19	200	8-19	200	310	257	21
100	8-19	220	8-23	235	350	275	30
125	8-19	250	8-28	270	400	332	45
150	8-23	285	8-28	300	480	396	65
200	12-23	340	12-28	360	600	498	123
250	12-28	405	12-31	425	730	555	195
300	12-28	460	16-31	485	850	630	320
350	16-28	520	16-34	555	980	733	440
400	16-31	580	16-37	620	1100	800	630
450	20-31	640	20-37	670	1200	810	885
500	20-34	715	20-37	730	1250	900	1125

## Operating Instruction

Methods of setting balancing valve according to the given differential pressure. (For example: The preset value is 4.5 ring opening).

Operation methods:

1. Fully close the valve. (Figure 1)
2. Open valve to the preset value. (Figure 2)
3. Tighten internal valve stem clockwise with allen wrench.
4. Complete the valve setting.

How to check the preset value: close the valve and the reading is 0.0 ring. Turn handwheel until stopping and the reading is default value (It is 4.5 ring, see figure 2).

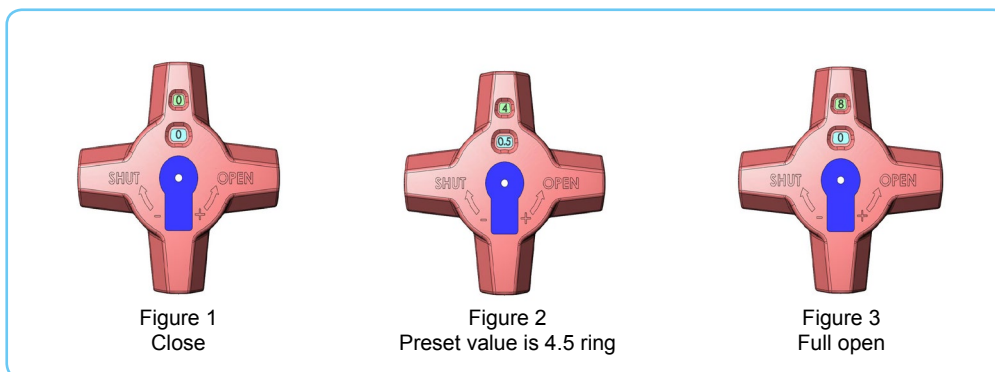

## Technical Parameters

### • Operating Parameters

Caliber range	DN15~DN500
Permissible pressure	PN16, PN25 are optional
Connection standard	DN15~DN50 Female Threaded Connection ISO7-1 DN50~DN500 Flanged Connection ISO7005-2
Leakage rate	DN15~DN150 0 leakage DN200~DN500 $\leq 0.02\%$ Kvs
Medium temperature	DN15~DN50 -10~120°C DN50~DN500 -10~150°C

### • Spare Parts Material

Valve body	DN15~DN50 Brass Hpb59-1 DN50~DN500 Ductile iron QT450-10
Valve stem	DN15~DN50 Brass DN50~DN500 Stainless steel
Valve core	DN15~DN50 Brass DN50~DN500 Stainless steel+ductile iron
Handwheel	DN15~DN50 PA DN50~DN500 Aluminum die casting

## Flow Chart

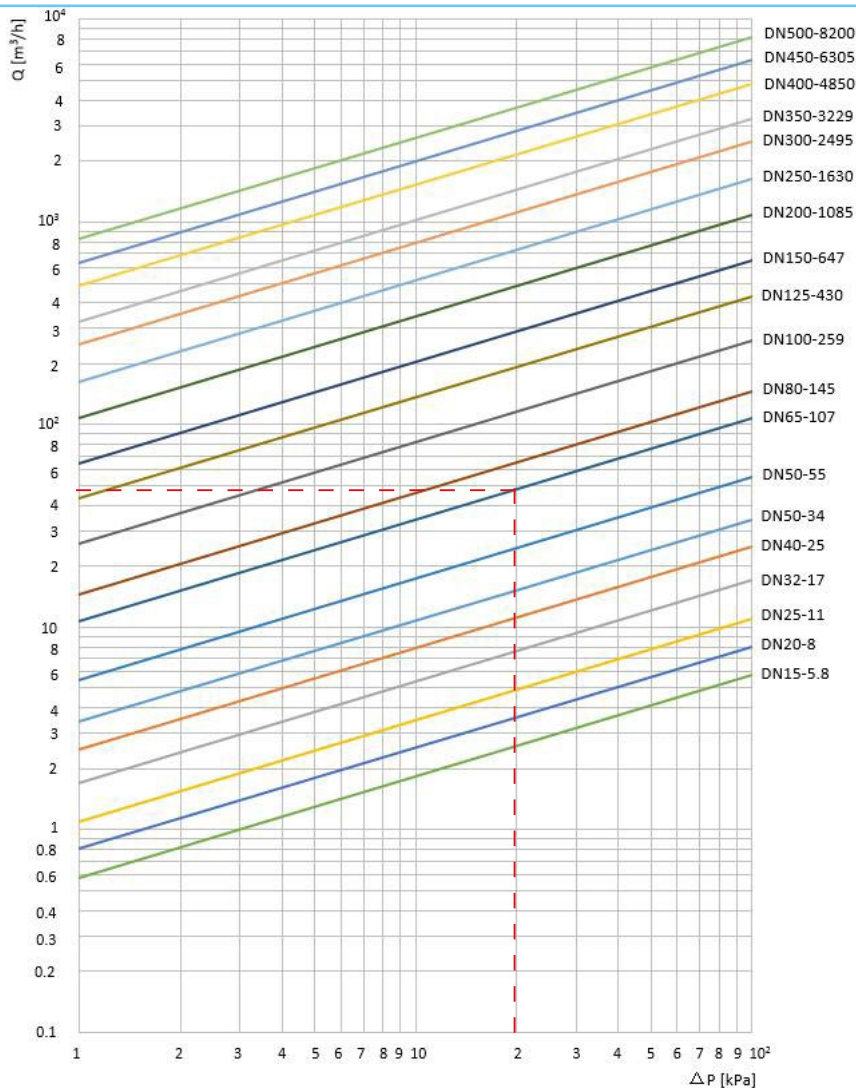

As shown in the left, it is the flow chart of Static balancing valve DN15-DN500 when the valve is full open.

For example:  
When the TJF65-T (DN65) is full open,  $\Delta P = 20$   $kPa$   
the  $Q_{max}$  is about  $50$   $m^3/h$ .

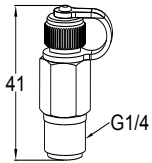

**Test plug**

High pressure end is in red, low pressure is in blue.

Specifications	Article No.
Red	CY-001-R
Blue	CY-001-B

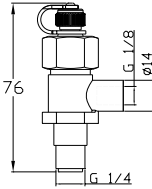

**3-port test plug with shut-off function**

With two test plug and shut-off function.

Article No.
CY-002

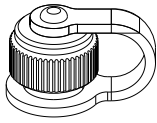

**Seal-capping**

Specifications	Article No.
Red	CY-003-R
Blue	CY-003-B

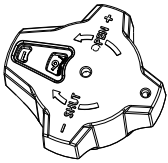

**Hand wheel**

Supplied with the valve

Specifications	Article No.
DN15~DN50	SL-001
DN65~DN150	SL-002
DN200~DN500	SL-003

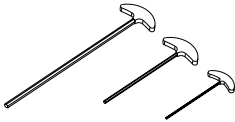

**Allen wrench**

Use for closing the valve

Specifications	Article No.
3mm	TPS-006-3
5mm	TPS-006-5
8mm	TPS-006-8

## Debugging Instrument



### Hydraulic Balancing Debugging Instrument

TPS-30KPA.BOX

TPS-200KPA.BOX

TPS is a debugging instrument for measuring and documenting of differential pressure, flow, temperature and power consumption in hydronic systems. It connects to the specialized APP software in an Android phone via bluetooth which could debug faster and more economical.

#### • Technical Parameters

Max. Permissible Pressure	1000kPa
DP Measurement Range	TPS-30KPA.BOX: 0~30kPa TPS-200KPA.BOX: 0~200kPa
Pressure Range during Flow measurement (Recommended Value)	TPS-30KPA.BOX: 3~30kPa TPS-200KPA.BOX: 3~200kPa
Measured Deviation	DP Sensor: $\leq 0.5\%$ Flow: DP Deviation+ Valve Deviation
Battery Capacity	3000mA
Operating time	>20h
Charge time	6h
Ambient Temperature	Operating and charging status: 0~40°C Storage condition: -20~60°C (Please exhuae the water in sensor when there is a risk of freezing)
Ambient Humidity	Max. 90% RH
Charger	Output Voltage: 12.6V DC Output Current: 500mA

## Debugging Software

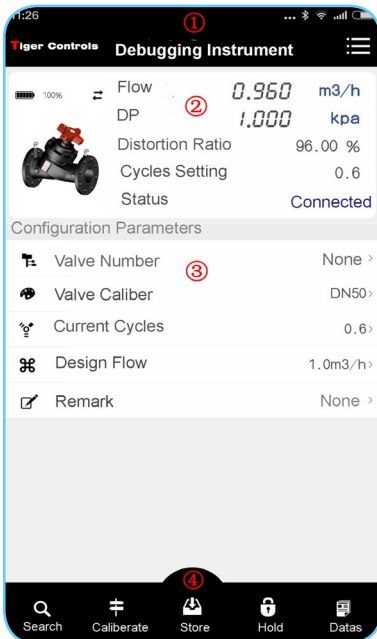

①Menu Bar: include language, settings, tools, software and database version.

Language: Chinese and English Switch

Settings: set the general operating information, such as project name, company selection and so on.

Tools: reserved

About: software and database version

②Display Bar: The left shows the battery status, product icon, when the connection works, the icon will flicker. The right shows the current flow, DP and current cycles, distortion ratio(actual flow/setting flow),connecting status of device and so on.

③Formula Bar: Input basic testing parameters, including valve number, caliber choice, current cycles, design flow, remark info. and so on.

④Operation Bar: Include search, calibrate, store, hold, data and so on.

Search: search for Bluetooth devices.

Calibrate: calibrate the zero drift of the instrument.

Store: store the current measuring value.

Hold: hold the current data.

Data: view the current records and XLS spreadsheet management.

Follow the “TigerControls”WeChat Official Account



[www.tiger-control.com](http://www.tiger-control.com)

*Information contained in this document, such as product design, specifications, or appearance, is subject to change without notice.  
This information is for reference only, please prevail in kind when buying.*

**Tiger Controls**